

4級基準点 点の記

T 1

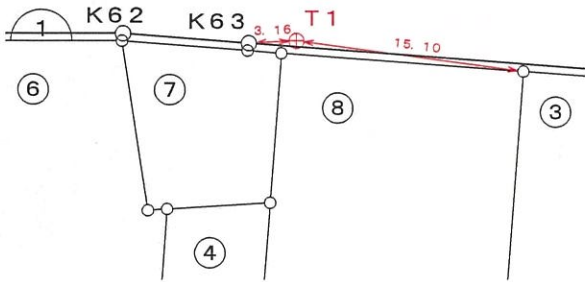

T 2

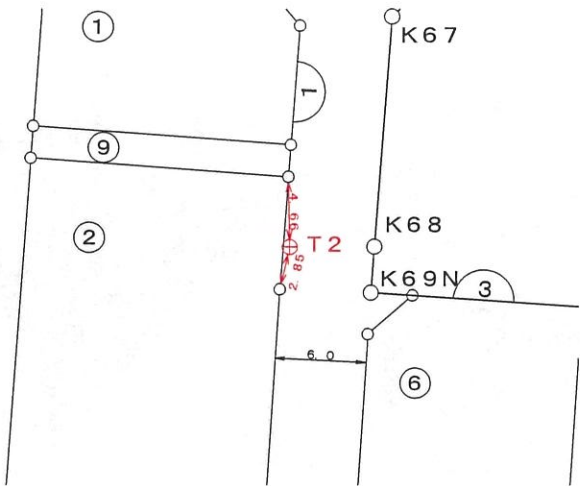

T 3

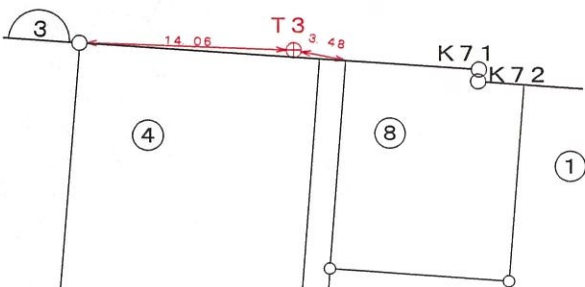

4級基準点 点の記

T 4

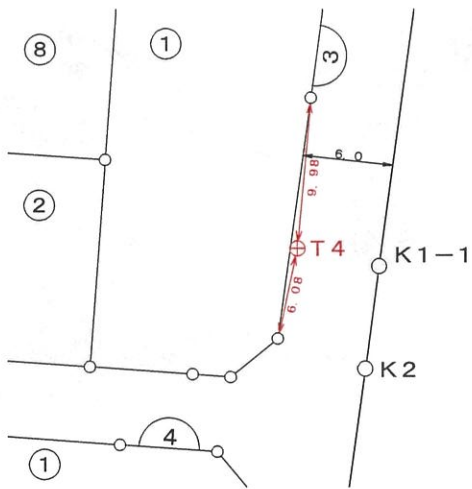

T 5

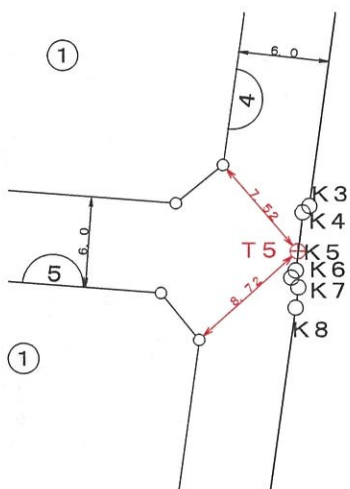

T 6

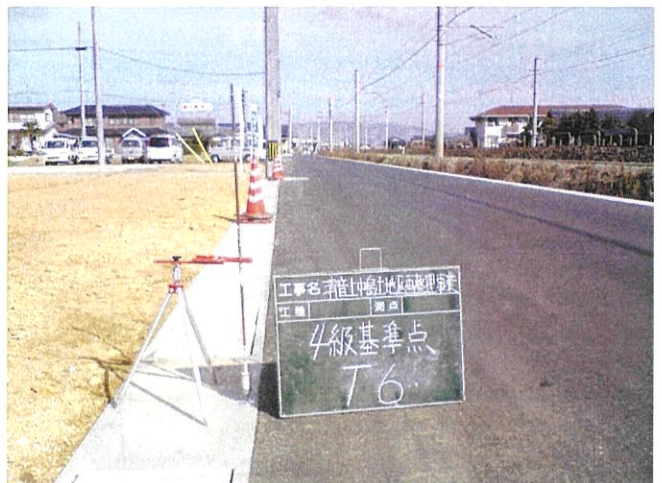
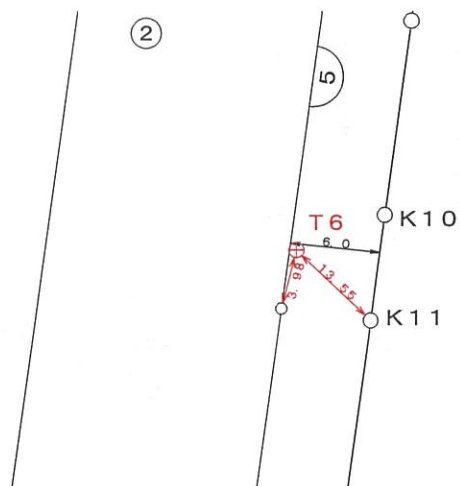

4級基準点 点の記

T 7

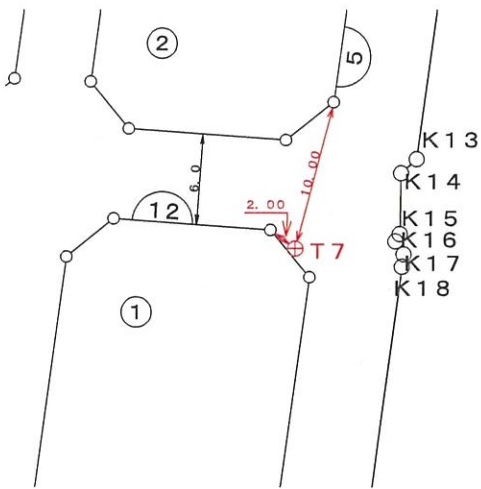

T 8

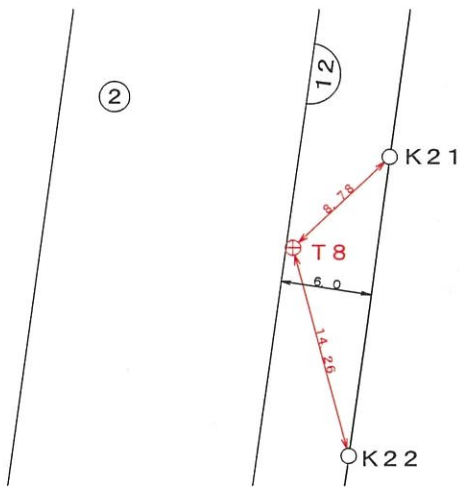

T 9

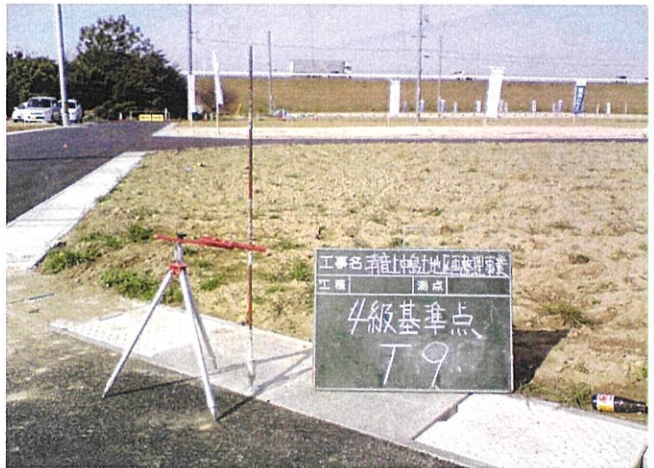
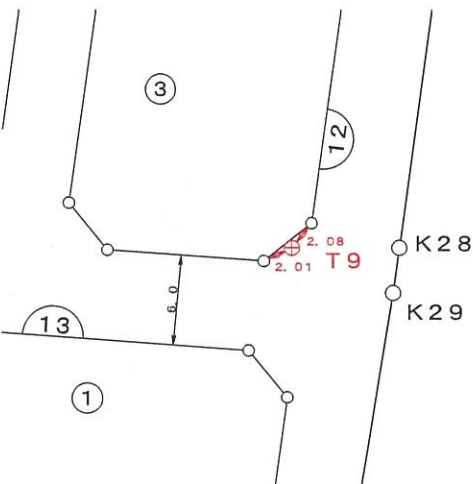

4級基準点 点の記

T 1 0

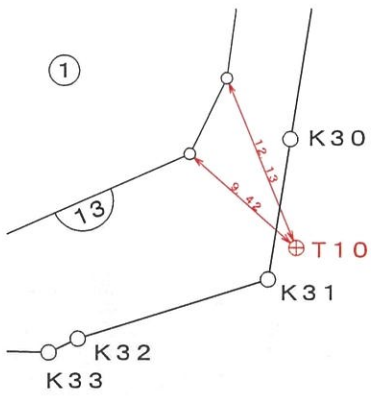

T 1 1

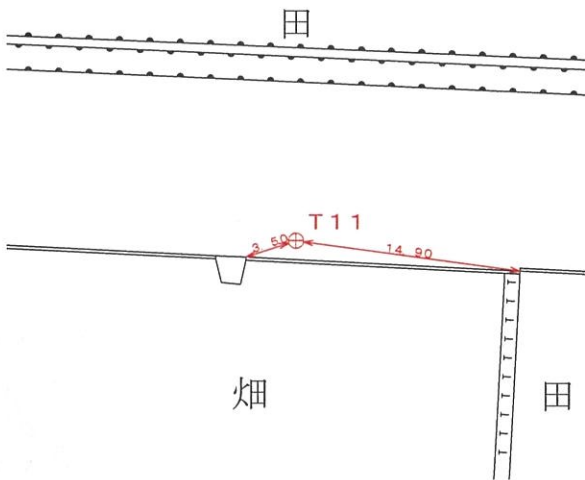

T 1 2

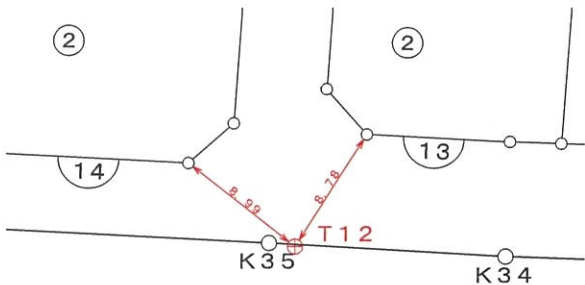

4級基準点 点の記

T 1 3

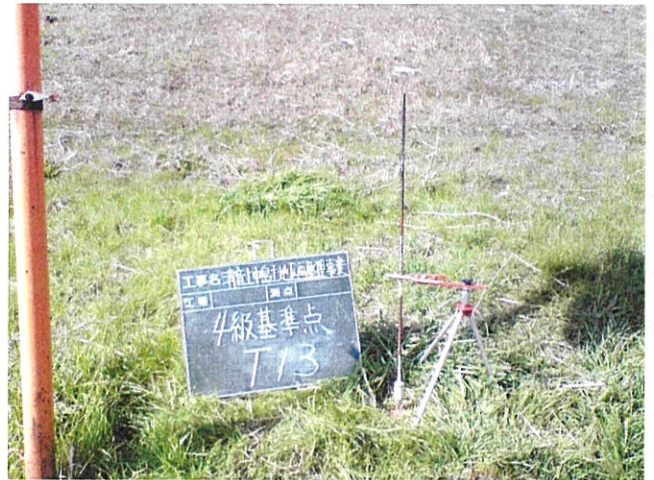
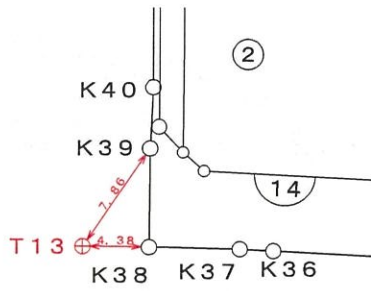

T 1 4

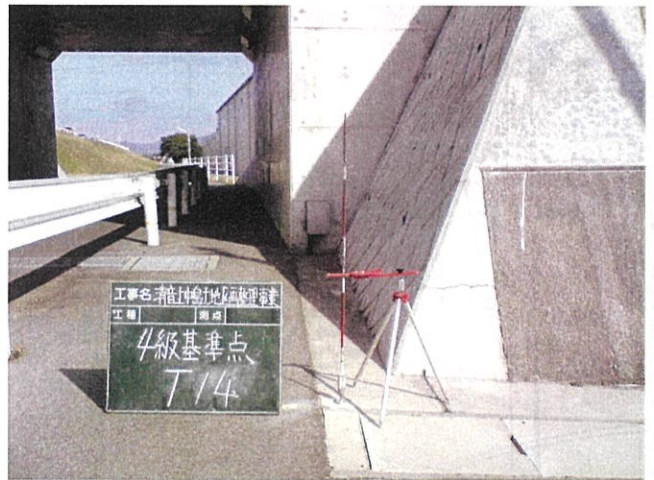
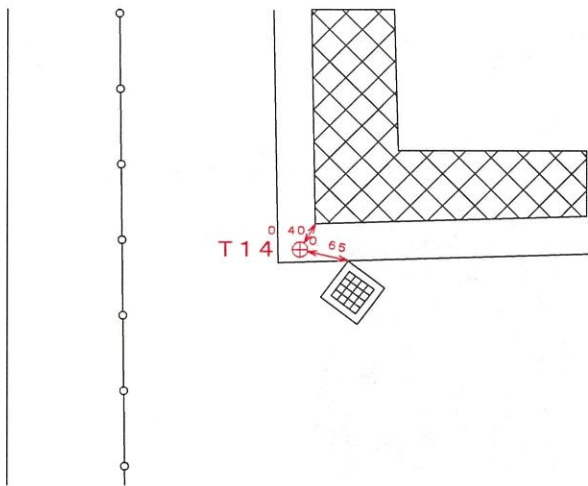

T 1 5

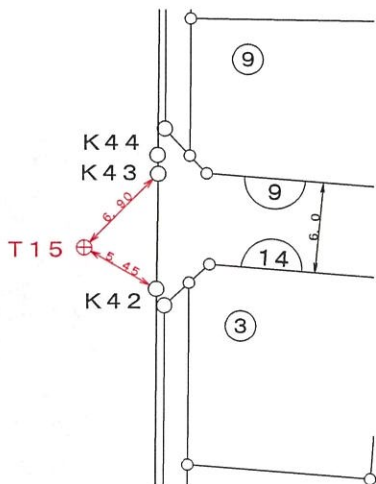

4級基準点 点の記

T 1 6

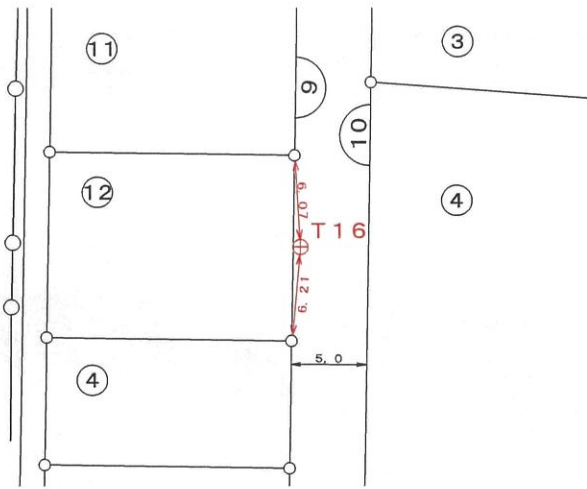

T 1 7

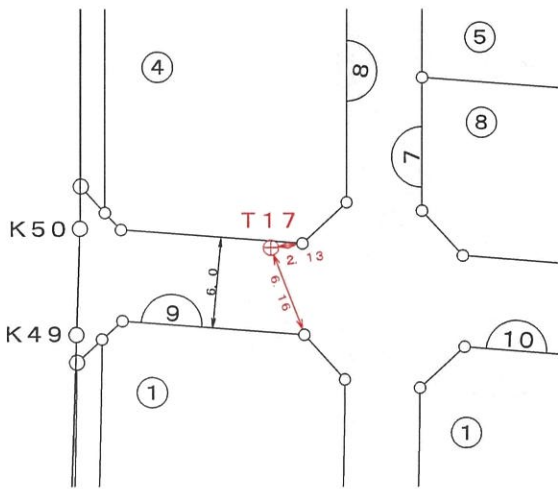

T 1 8

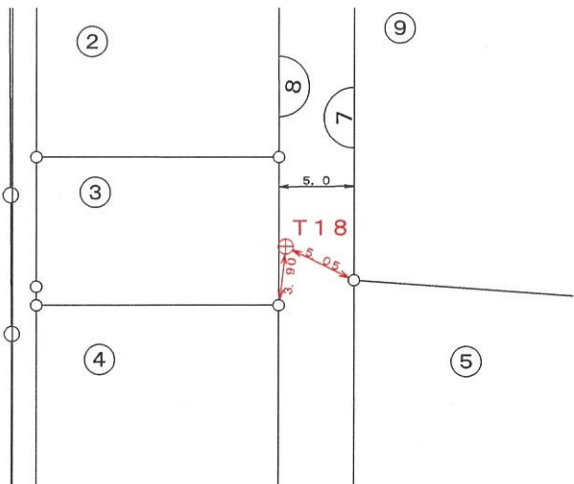

4級基準点 点の記

T 1 9

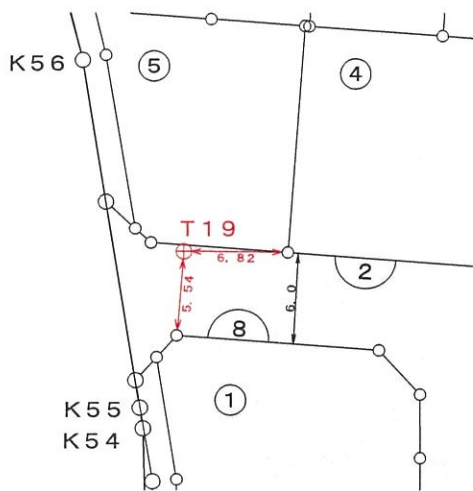

T 2 0

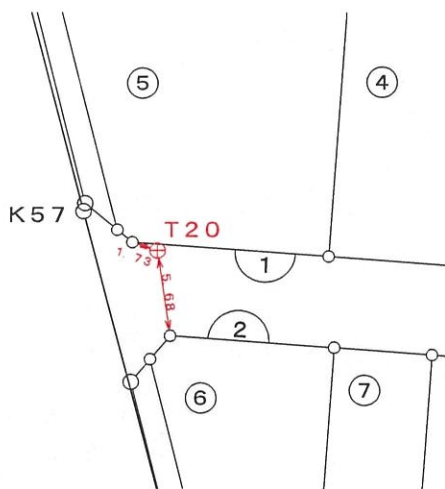

T 2 1

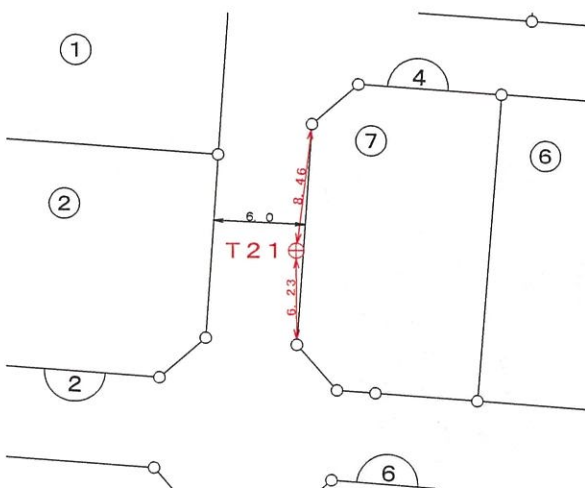

4級基準点 点の記

T 2 2

017

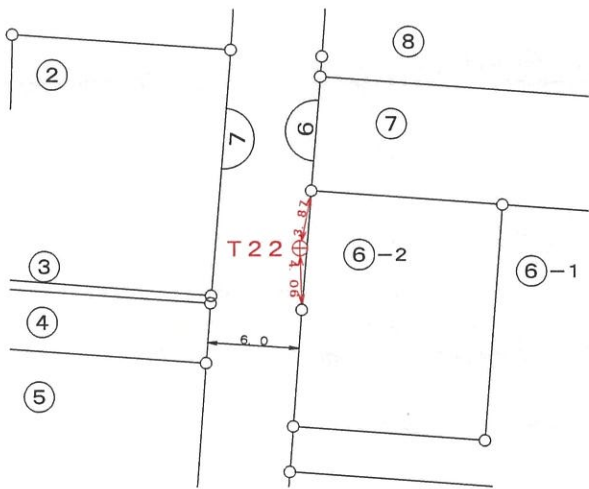

T 2 3

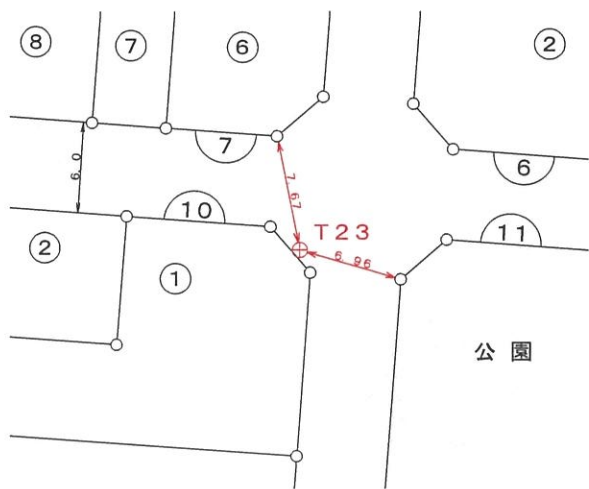

T 2 4

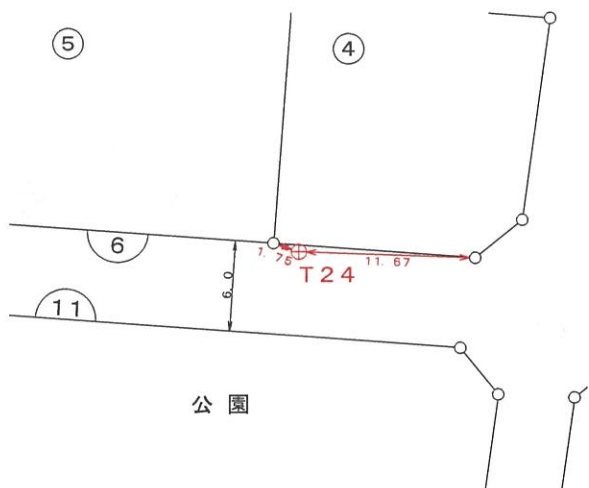

4級基準点 点の記

T 2 5

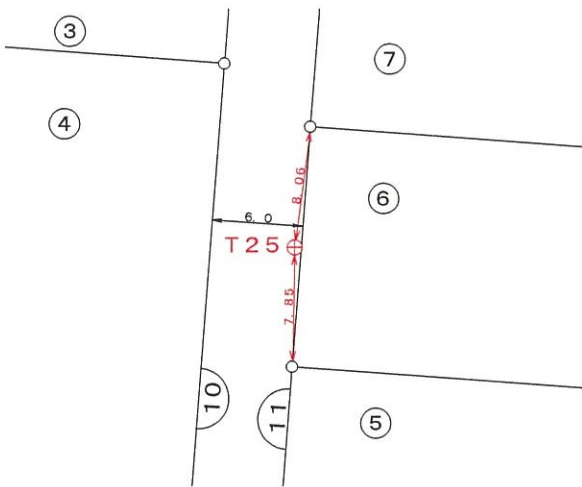

T 2 6

